

Guarantee registration

Appliance model

Serial no.

Date of purchase

Customer name

Address

CUT HERE & DETACH

Please help us to further improve our products by ticking the one main reason for purchase

Price

Styling/Appearance

Features

Previous Burco ownership

Dealer recommendation

Service back-up

Other (please state)

Where did you buy your Burco appliance ?

Dealer/Retailer

If you do not want Burco to keep you informed of future products and offers, please tick here

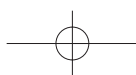

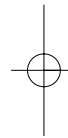
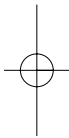
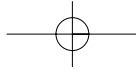

Burco Appliances products are intended for commercial use only as detailed in these instructions.

Burco Appliances has a policy of continuous improvement in product quality and design. The Company, therefore, reserves the right to change the specification of its models at any time.

Burco Appliances Limited

A MEMBER OF THE GLEN DIMPLEX GROUP

Talbot Road, Mexborough,
South Yorkshire, S64 8AJ

Tel 01709 577120 **Fax** 01709 579905

Email sales@burcodean.co.uk

BURCO

CP76100MUK Rev 2 11/05

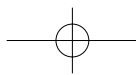

BURCO

Portable hand wash unit

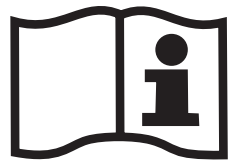

Please read and keep these instructions

Model 76100
Dimensions
H1010mm, W400mm, D430mm
10 litre capacity
Approx 50 handwashes

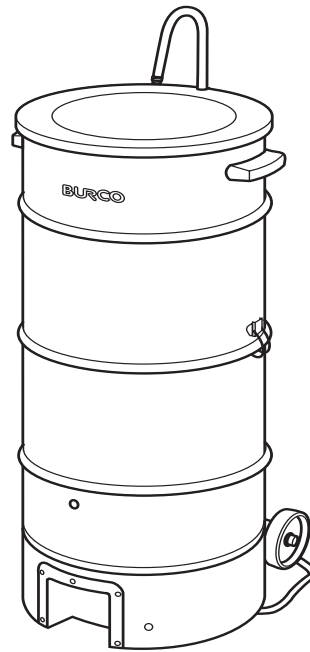

Getting the best from your unit...

- A residual current device (RCD) should be used with this unit.
- It is important to descale as the performance of the unit will be impaired.
- Always put water in the unit before using.



www.burco.co.uk

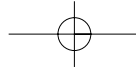

Important safety instructions

The use of any electrical appliance requires following common sense safety rules.

Primarily there is danger of personal injury and secondly danger of damage to the appliance and property. These are indicated in the instructions text by the following two conventions:

WARNING: Danger of personal injury

IMPORTANT: Damage to the appliance

In addition we offer the following essential safety advice.

Location

- The unit should only be operated on a flat, level surface.
- The unit should only be operated on a dry surface avoiding any possibility of water ingress into the lower electrical compartment.

Personal safety

- **WARNING: The unit should not be lifted or moved whilst connected to the mains.**
- **WARNING: To prevent any risk of electrocution do not immerse the unit in water or any other liquid when cleaning and do not allow any water or liquid to come into contact with any of the electrical connections or controls.**

Mains cord

- If the mains cord or plug of this unit is damaged it must be replaced by the manufacturer. Contact our service helpline for assistance.
- Always switch off and disconnect the unit from the mains when not in use or when cleaning.

Children

- Children do not understand the dangers associated with operating electrical appliances. Never allow children to use this appliance.

Other safety considerations

- Do not operate with a damaged lead or plug, or after an appliance has malfunctioned, or has been dropped or damaged in any way. Contact Burco Appliances for advice on examination, repair, or electrical or mechanical adjustment.
- Do not dismantle any part of the unit. Responsibility cannot be accepted if this instruction is ignored.
- This appliance must only be used for hand washing, it is not intended for dish washing.
- Maintenance other than cleaning should be performed by the manufacturer while this product is within guarantee (contact our service helpline) or otherwise by a qualified service engineer.
- Unplug from the mains outlet when not in use and before cleaning.

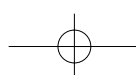
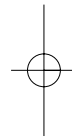
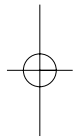

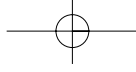

Guarantee

.....

This electric portable handwash unit is guaranteed for a period of 12 months from the date of purchase against defective materials or faulty workmanship.

This guarantee is given subject to the unit being used in accordance with the instructions of the supply voltage marked on it and to the usual fair wear and tear conditions.

The guarantee does not cover consequential damage arising out of any failure acceptable under guarantee, nor does it cover damage resulting from misuse, accident or unauthorised alterations to the unit.

Proof of purchase will be required.

In any communication with the manufacturer, it is essential to quote the model and serial number marked on the rating plate.

This guarantee, in no way diminishes the buyer's statutory rights.

Please fill in and return the tear off section to register the guarantee with Burco.

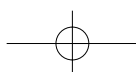
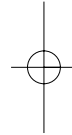
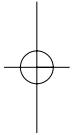

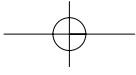

Marketing Department
Burco Appliances Ltd
Talbot Road
Mexborough
South Yorkshire
S64 8AJ

Affix
postage
stamp
here

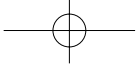

CUT HERE & DETACH

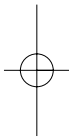

Electrical requirements

Check that the voltage on the rating plate of your appliance corresponds with your electricity supply which must be A.C. (Alternating Current).

If the socket outlets are not suitable for the plug supplied with this appliance, the plug should be removed and the appropriate one fitted.

WARNING: The plug removed from the mains lead, if severed, must be destroyed as a plug with bared flexible cord is hazardous if engaged into a live socket outlet.

WARNING: This appliance must be earthed.

Should the fuse in the 13A plug require changing, a 13A BS 1362 fuse must be fitted.

A residual current device (RCD) should be used with this unit.

The RCD must be plugged directly into the socket and the appliance plugged directly into the RCD.

Features

- 1 Waste bucket and lid (inside)
- 2 Water spout
- 3 Sink bowl
- 4 Latches holding top and bottom sections together.
- 5 Handle(s)
- 6 Stainless steel tube (inside the unit)
- 7 Wheels (on back left and back right of unit)
- 8 Overflow
- 9 Infra red housing
- 10 Upper section
- 11 Lower section

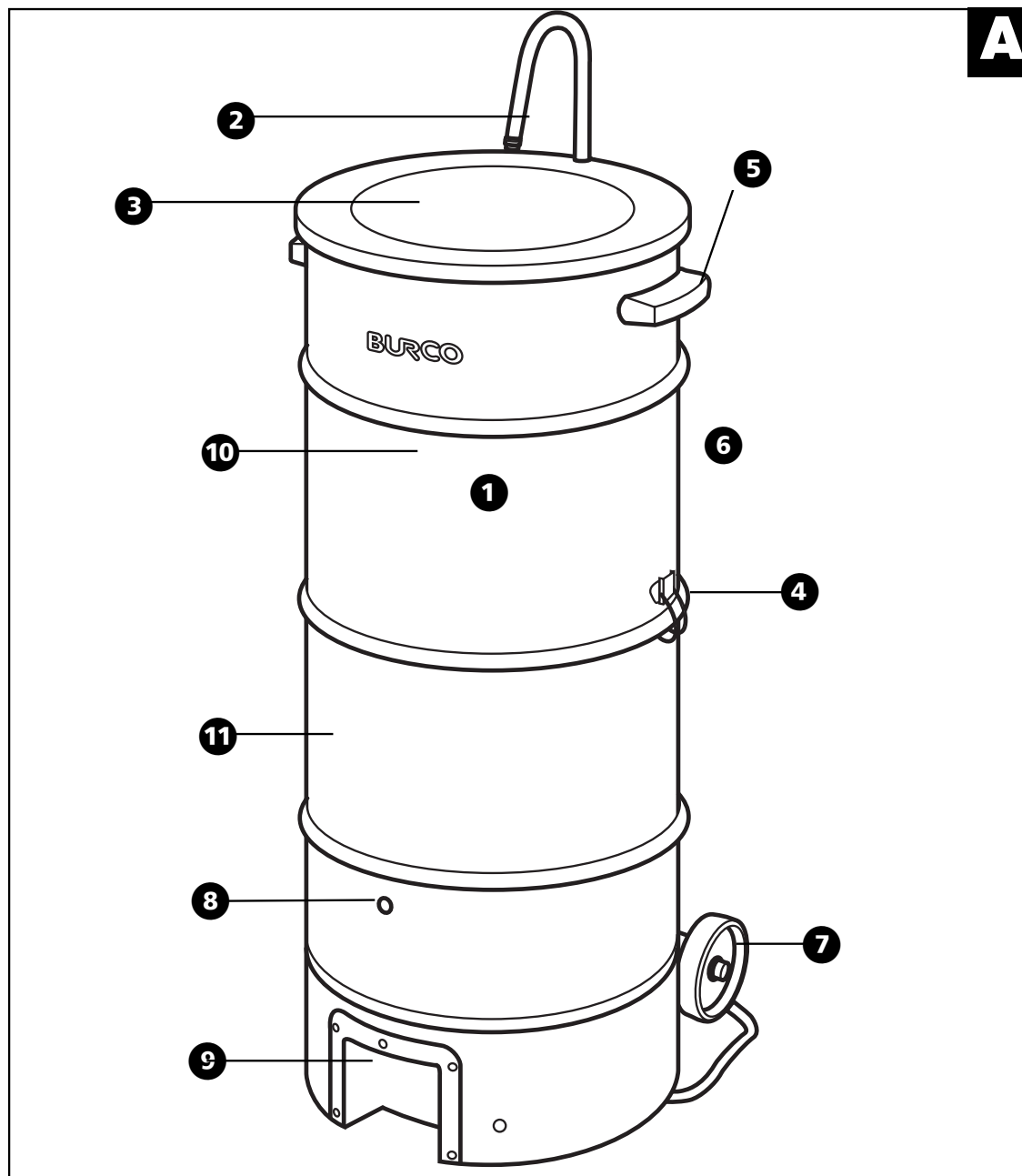

Preparation

- 1 Remove any plastic film before using the unit.
- 2 Check that the voltage shown on the rating plate is suitable for your supply.
- 3 Only use on a flat, level surface. Only use on a dry surface.
- 4 When moving unit, please use side handles.

Using

IMPORTANT: Always put water in the unit before switching on.

- 1 Lift out the bowl by the edges raising it off the upper section and sliding it up the water spout. When it is high enough, rotate the bowl and tap to the right (anti-clockwise) until it is clear of the opening of the upper section.
- 2 Lift out the waste container,

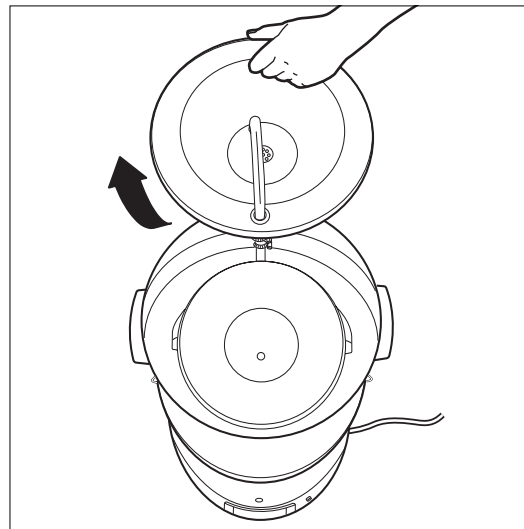

remove the lid and check to see that it is empty. This container must be empty before use otherwise there is a chance of over filling.

- 3 Replace the waste container in the top section and replace the bowl, reversing the process used when lifting it, ensure that it is fitted snugly back in place.

Filling

- 1 To fill, release the catches situated either side of the handwash that secure the upper section to the lower. Lift the upper section until it is clear of the lower section noting two cutouts in the bottom edge.

These are to be positioned on the left hand side of the rolled edge of the lower

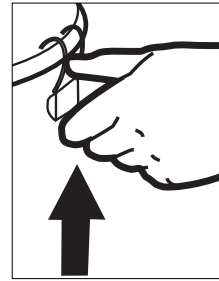

container giving it a resting position and allowing hands

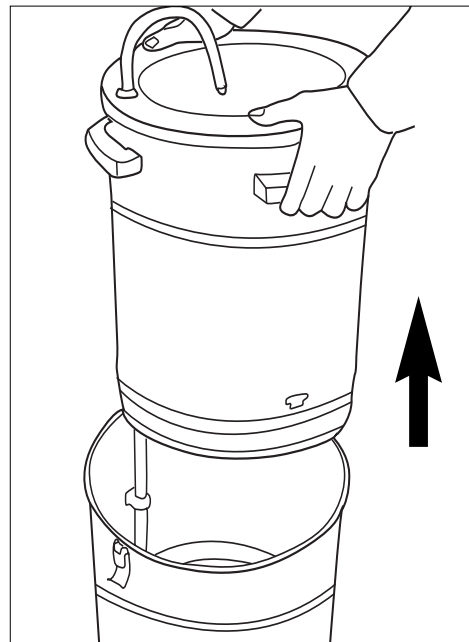

free access for filling.

- 2 Pour clean potable water into the lower section. Never fill beyond the MAX fill mark (10L) otherwise water will flow out of the overflow.
- 3 When filled with the desired amount of water lift the upper section and replace it on the lower section. (Both container seams should be lined up). Failure to correctly align these sections will result in difficulty latching the two parts together and may damage the latches themselves.
- 4 Relatch the catches ensuring the wire retainers are situated above the cleat on

the upper section. Be careful to avoid catching any part of yourself when this catch snaps into place.

- 5** Plug into the supply and the NEON light will illuminate to indicate power to the unit.
- 6** Put your foot into the black plastic moulding located at the bottom of the unit to operate the handwash. Run the hand wash two cycles. This will prime the pump. No water will be dispersed until this is taken place.
- 7** The unit takes approximately 15 mins to reach full temperature.
- 8** The unit is then ready for operating.

Hand Washing

- 1** To operate place your foot momentarily into the black plastic moulding at the front of the lower unit. This activates an infra red beam, which in turn pumps water out of the water dispensing nozzle for a period of approximately 7 seconds. The operation can be repeated by momentarily putting your foot back into the plastic moulding once the previous pouring has stopped.

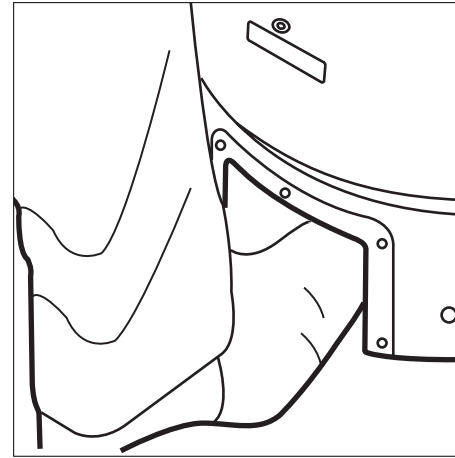

- 2** When the water stops dispensing from the nozzle when activated, the lower tank may be empty and the unit should be switched off. (Remove the plug from the socket). If there is water remaining in the lower section please check that the hose is securely attached to the upper section pipe. See cleaning and descaling. If neither of these actions resolve the problem, please call our helpline.
- 3** Remove the sink bowl and empty the waste container (as previously instructed). **IMPORTANT:** It is essential that this is carried out before re-filling the lower container.
- 4** Replace the sink bowl and refill the lower container as previously instructed.

After use

Switch off (disconnect from the mains) and empty waste container as previously instructed.

Protective cut-out

The heating element is fitted with a thermal cut-out which protects the handwash unit from damage, if it is allowed to boil

dry or is switched on without water. The cut-out re-sets automatically as the boiler cools off.

In order to ensure correct operation of this cut-out it is essential to keep the heating element free from scale. Failure to do this will result in the cut-out operating before the water has heated.

Cleaning and descaling

- Lift out the bowl by the edges raising it off the upper section and sliding it up the water spout.
- When it is high enough, rotate the bowl and tap to the right (anti-clockwise) until it is clear of the opening of the upper section.
- Locate the quick release fitting, this is the large white plastic section joining two steel pipes.

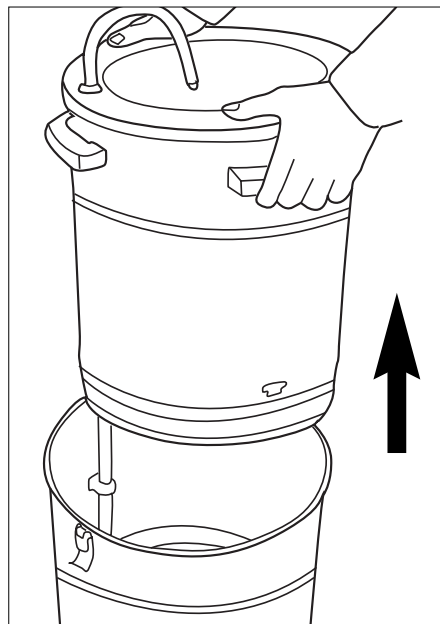

Ensure that the bezel is unscrewed to its fullest extent.

- Grip the white fitting and pull the plastic ring at the bottom of the fitting towards the body of the plastic joint firmly.
- While these two parts are pulled together this will

release the lock and allow pipes from upper and lower sections to separate.

- Release catches and separate upper and lower sections. **Note:** Never clean the unit when it is still hot - wait for it to cool completely to avoid any chance of burns. To fully remove the upper section from the lower section open them as for filling.

IMPORTANT: To descale, we recommend you use the

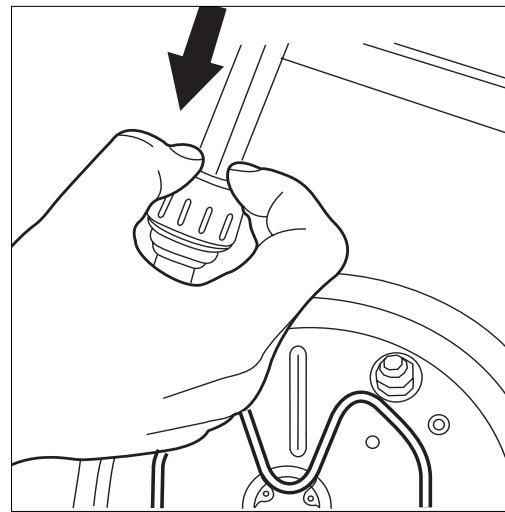

proprietary descaler which is especially made for water boilers. Follow the manufacturer's instructions, and then operate the water boiler with just water 3 times before use.

Do not use the water boiler descaler unless the manufacturer specifically states it is suitable for water boilers.

IMPORTANT: Failure to descale will invalidate your guarantee.